

INO825X-RAWT

Premium Series 8MP IR WDR Outdoor Speed Dome PTZ Camera 25X

Infinique offers a wide range of IP based high definition cameras available in housing formats, including Dome, Bullet, Box and PTZ. Our cameras are equipped with superior image sensor and digital signal processor to produce sharp, crisp pictures and are enclosed in weather and vandal resistant housings making it suitable for use in all security applications. The ONVIF compliance of the cameras helps in easy integration, providing peace of mind for your investment. From small to very large installations, Infinique's cameras are reliable, future proof and an ideal solution for your video surveillance needs.

Infinique's 8MP IR PTZ comes with 25X Optical Zoom with 130dB true WDR. It is compact in size with a reliable mechanical design that offers precise positioning and predictable high-speed tracking. This high quality PTZ dome provides excellent image quality in difficult lighting conditions and provides features such as privacy zone blanking, guard tours, multiple presets, alarms which are required for efficient 24/7 surveillance.

This camera is equipped with smart IR and has a night vision of up to 100m and provides crisp and clear images both during day and night. It can pan with a continuous 360° degree rotation at a very high preset speed of 120° per second.

An easy to install design with wall, ceiling and pole mount brackets allows for quick installation, makes it a suitable choice for any indoor and outdoor application such as large retail stores, malls, airports, factories, warehouses, airports, government buildings where detailed video surveillance is essential.

Product Features

- 1/2.8" Progressive Scan Image Sensor
- 8MP Resolution at 25/30 fps
- Smart IR, IR Distance 100m
- 130dB True WDR
- 25X Optical Zoom
- H.265+, H265, H264+, H.264 Compression
- Up to 3 Simultaneous Video Streams
- Track targets with 360° Rotation
- Preset/Tour/Scan/Pattern Function
- True Day & Night with ICR Cut Filter
- S/N Ratio of more than 50dB
- Micro SD Card Slot for Onboard Storage
- Audio I/O, Alarm I/O
- Vandal Proof Aluminum Alloy Housing
- IP67 Rated
- Easy control by Keyboard (OSD)
- ONVIF Compliant



Dimensions

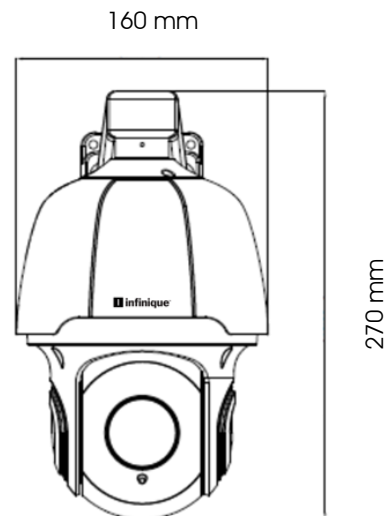

Accessories



Part No: IBKTWM
Wall Mount Bracket



Part No: IBKTCM
Ceiling Mount Bracket



Part No: IBBCPM
Pole Mount Bracket

INO825X-RAWT

Premium Series 8MP IR WDR Outdoor Speed Dome PTZ Camera 25X



IMAGE PERFORMANCE		NETWORK	
Image Sensor	1/2.8" Progressive Scan CMOS	Network Port	10/100M BASE-TX, RJ-45 Connector
Resolution (H x V)	3840 x 2160	Cabling Type	Category 6 and higher
Minimum Illumination	Color 0.007 lux with AGC On, B/W 0 lux with IR	Network Protocol	IPv4/6, HTTP, HTTPS, TCP/IP, UDP, RTP, RTSP, RTMP, SNMP, DNS, DDNS, DHCP, FTP, NTP, PPPOE, SMTP, UPNP, ICMP
Image Rate (FPS)	25 / 30	ONVIF Protocol	ONVIF Compliant Profile-S, G, T
IR Distance (m)	100	Security	User Access with password protection, IP Filtering
IR Dimming	Adjustable	Users	1 Administrator, 4 Users
S/N Ratio	More than 50dB	PC Web Browser	IE 6.0 Above; Mozilla Firefox; Google Chrome
LENS		Mobile Device	Android, iPhone
Focal Length (mm)	4.7 ~ 90	Events	Motion, Sensor, Network Failure
Iris	DC Auto Iris, Manual	Event Handlers	Pre-Post Event Image, FTP, E-mail, SD Card Recording
Aperture Ratio	F1.6	PTZ CONTROL	
Angle of View (deg)	Wide 54 ~ Tele 3.8	Pan/Tilt Angle (deg)	Pan: 360 Endless / Tilt: -10 to 95 / Auto Flip
Zoom Ratio	25X Optical Zoom	Pan Speed (deg)	0.6° to 80° per sec
VIDEO AND AUDIO		Tilt Speed (deg)	0.6° to 100° per sec
Video Compression	H.265 Main Profile H.264 Baseline Profile/Main Profile/High Profile	Preset Speed / Positions	120° per sec / 255 Positions
Main Stream	3840x2160, 3072x1728, 2592x1944, 2592x1520, 2304x1296, 1920x1080, 1280x960, 1280x720	Tour	4 Group Tours, Each tour up to 8 Presets
Sub Stream	1920x1080, 1280x720, 640x480, 320x240	Scan	1 Programmable Scan
Mobile Stream	640x480, 320x240	Pattern	4 Patterns
Electronic Shutter Control	1/5 ~ 1/20000	Default Position	Preset / Tour / Scan / Pattern
Day/Night Control	IR Cut Filter with Auto Switch	Communication	RS-485 - 2400, 4800, 9600, 38400 bps
Flicker Control	50 Hz, 60 Hz	RS-485 Protocol	Pelco-D, Pelco-P
True WDR	130dB	MECHANICAL	
White Balance	Auto / Manual / Indoor	Housing ID	V4POMWH671010S1
Backlight Compensation	On / Off	Dimensions (mm)	160 (D) x 270 (H)
Automatic Gain Control	Auto/Manual, Adjustable Level	Weight (g)	2500
Smart Defog	Supported	Housing	Vandal Resistant Aluminum Alloy Housing
Audio Compression	G.711A/G.711U/G.726	Finish	White Powder Coat, RAL 9003
Audio Input / Output	Line level input and output, 3.5mm A/V Interface	Installation	Ceiling / Wall / Pole Mount
Video Output	IP-RJ45, CVBS-BNC Type	ELECTRICAL	
Alarm I/O	1 Alarm Inputs, 1 Relay Output (N.O)	Power Consumption	22W
Video Bit rate	32Kbps~16Mbps, Supports CBR/VBR	Power Source	PoE IEEE802.3af; DC12V; AC 24V
OSD	Camera ID, Pan/Tilt Angle, Mode, Zoom Ratio Setting/ Control via Joystick	Power Connector	2 pin terminal block
Image Orientation	Image Flip, Mirror	RTC Backup Battery	3V Magnesium Lithium
Image Controls	Brightness, Contrast, Hue, Saturation, Acu, Gamma	ENVIRONMENTAL	
Advanced Functions	Image Rotation, Anti-Fog, Smart IR Detection	Operating Temperature (C)	-30 to 60
VIDEO ANALYTICS		Storage Temperature (C)	-20 to 60
Advance Video Analytics	Tamper, Out Of Focus, Sound, Perimeter Intrusion, Line Crossing, Stationary Object, Pedestrian Detection, People Counting, Face Detection, Smart Tracking	Operating Humidity	0% - 90% non condensing
LOCAL STORAGE		Ingress Protection Rating	IP67
Memory Card Slot	Micro SD/SDHC/SDXC, Max 256GB Slot	Impact Rating	IK07
Recording	Video and Image; Auto / Manual; Motion, Alarm Trigger, Schedule	STANDARDS COMPLIANCE	
ORDERING INFORMATION		Emissions	FCC Part 15 Subpart B Class B EN 55022:2010, IC ICES-003 Class B
PART NUMBER	DESCRIPTION	Immunity	EN 55024:2010
INO825X-RAWT	Infinique Premium Series Outdoor IR PTZ Speed Dome IP Camera, 1/2.8 CMOS Sensor, 8MP, 25X Optical Zoom, H.265, H.264, Three Stream, 130dB WDR, True Day and Night with ICR, Adjustable Bit Rate, ONVIF Compliant, Audio, SDHC Slot, IP67, IK07	Safety	UL 609501, EU: 2001/95/EC GSPD
IBKTWM	Infinique PTZ Camera Wall Mount Bracket		
IBKTCM	Infinique PTZ Camera Ceiling Mount Bracket		
IBBCPM	Infinique Outdoor Pole Mount Bracket with Metal Ties		



Infinique, a Canadian company is a manufacturer of high performing end-to-end solutions in copper, fiber and video surveillance systems. For more information visit our website at www.infinique.com or email us at sales@infinique.com.

INO825X-RAWT

Premium Series 8MP IR WDR Outdoor Speed Dome PTZ Camera 25X



Housing Accessories

WALL MOUNT APPLICATION



Wall Bracket
IBKTWM

CEILING MOUNT APPLICATION



Ceiling Bracket
IBKTCM

POLE MOUNT APPLICATION



Pole Bracket
IBBCPM



Wall Bracket
IBKTWM



Infinique, a Canadian company is a manufacturer of high performing end-to-end solutions in copper, fiber and video surveillance systems. For more information visit our website at www.infinique.com or email us at sales@infinique.com.